



CITY OF CAMBRIDGE

MASSACHUSETTS

WATER DEPARTMENT
250 FRESH POND PARKWAY
CAMBRIDGE, MASS. 02138

617-349-4770

CROSS CONNECTION PROGRAM Backflow Prevention

TO: Backflow Prevention Installers

FROM: ANTHONY J. IPPOLITO

RE: Requirements For The Installation Of A Backflow Preventer Device

DATE

"Procedure"

The following procedure is required to obtain a Plumbing Permit for the installation of a backflow prevention device.

Entirely complete form BRP WS 09 CROSS CONNECTION PLAN APPROVAL (Design Data Form). Complete one form for each device.

A 8 1/2" X 11" sketch or schematic must accompany each Design Data Form.

Forms may be obtained from the secretary at INSPECTIONAL SERVICES or from the CROSS CONNECTION SECTION of the WATER DEPARTMENT located at 250 Fresh Pond Parkway, Tel. 349-4778.

MASSACHUSETTS REGULATION 248 CMR 79 c (2) "No plumbing permit shall be issued for cross connection installation requiring Reduced Pressure Zone Backflow Preventer or Double Check Valve Assemblies until the application for such permit is accompanied by a letter of approval from the Massachusetts Department of Environmental Protection or its designee". As the D.E.P.'s designee, The Cambridge Water Department will issue a letter of approval upon review and acceptance of the Design Data Sheet.

The Cross Connection Manager is available at 349-4778 to provide assistance or to answer questions relating to the requirements for the installation of Backflow Preventer Devices.

Anthony J. Ippolito

Cross Connection Manager

Tel: 349-4778

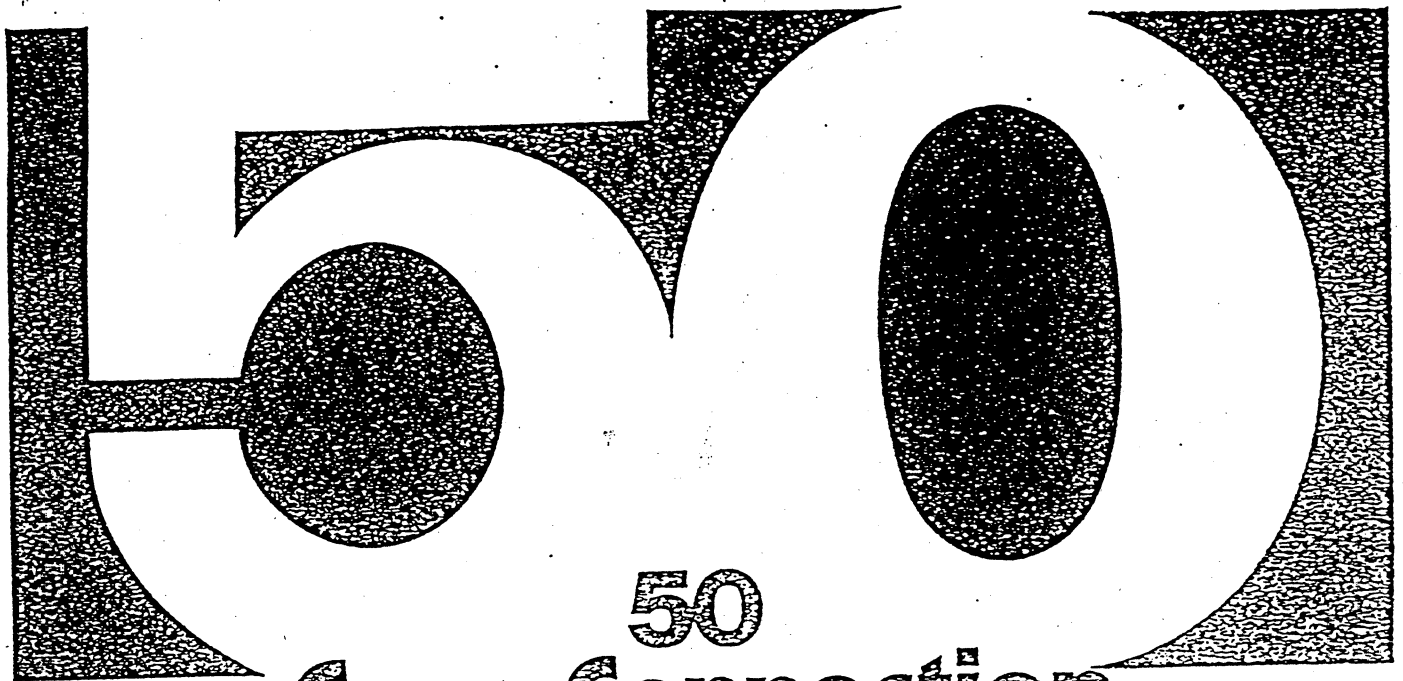

50
Cross Connection
Questions,
Answers,
& Illustrations

Relating To
Backflow Prevention Products
and
Protection of
Safe Drinking Water Supply

1 What is back-siphonage?

Back-siphonage is the reversal of normal flow in a system caused by a negative pressure (vacuum or partial vacuum) in the supply piping.

2 What factors can cause back-siphonage?

Back-siphonage can be created when there is stoppage of the water supply due to nearby fire-fighting, repairs or breaks in city main, etc. The effect is similar to the sipping of an ice cream soda by inhaling through a straw, which induces a flow in the opposite direction.



3 What is backpressure backflow?

Backpressure backflow is the reversal of normal flow in a system due to an increase in the downstream pressure above that of the supply pressure.

4 What factors can cause a back pressure-backflow condition?

Back pressure-backflow is created whenever the downstream pressure exceeds the supply pressure which is possible in installations such as heating systems, elevated tanks, and pressure-producing systems. An example would be a hot water space-heating boiler operating under 15-20 lbs. pressure coincidental with a reduction of the city water supply below such pressure (or higher in most commercial boilers). As water tends to flow in the direction of least resistance, a back-pressure-backflow condition would be created and the contaminated boiler water would flow into the potable water supply.

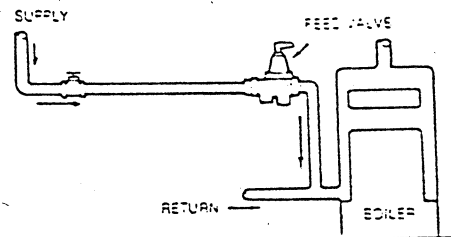

5 What is a cross connection?

A cross connection is a direct arrangement of a piping line which allows the potable water supply to be connected to a line which contains a contaminant. An example is the common garden hose attached to a sill cock with the end of the hose lying in a cesspool. Other examples are a garden hose attached to a service sink with the end of the hose submerged in a tub full of detergent, supply lines connected to bottom-fed tanks, supply lines to boilers.

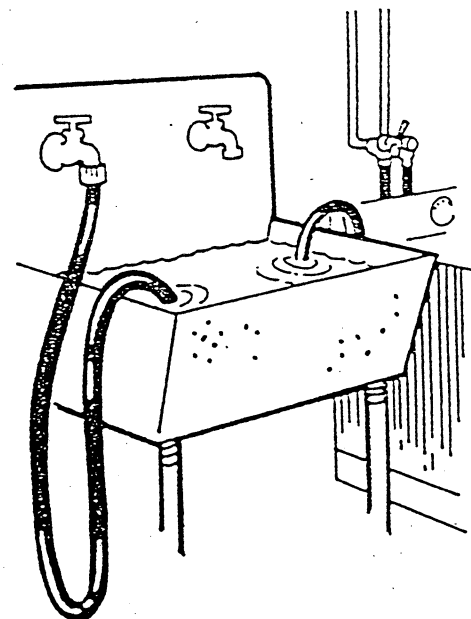

6 What is the most common form of a cross connection?

Ironically, the ordinary garden hose is the most common offender as it can be easily connected to the potable water supply and used for a variety of potentially dangerous applications.

7 What is potentially dangerous about an unprotected sill cock?

The purpose of a sill cock is to permit easy attachment of a hose for outside watering purposes. However, a garden hose can be extremely hazardous because they are left submerged in swimming pools, lay in elevated locations (above the sill cock) watering shrubs, chemical sprayers are attached to hoses for weed-killing, etc.; and hoses are often left laying on the ground which may be contaminated with fertilizer, cess-pools, and garden chemicals.

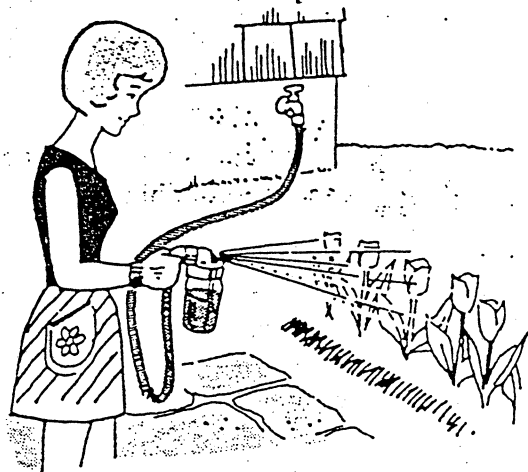

8 What protection is required for sill cocks?

A hose bibb vacuum breaker should be installed on every sill cock to isolate garden hose applications thus protecting the potable water supply from contamination.

9 Should a hose bibb vacuum breaker be used on frost-free hydrants?

Definitely, providing the device is equipped with means to permit the line to drain after the hydrant is shut-off. A "removable" type hose bibb vacuum breaker could allow the hydrant to be drained, but the possibility exists that users might fail to remove it for draining purposes, thus defeating the benefit of the frost-proof hydrant feature. If the device is of the "Non-Removable" type, be sure it is equipped with means to drain the line to prevent winter freezing.

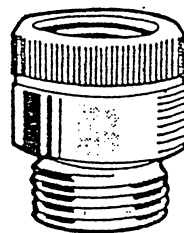

HOSE BIBB VACUUM BREAKER
No. 8

10 Can an atmospheric type, anti-siphon vacuum breaker be installed on a hose bibb?

Theoretically yes, but practically no. An anti-siphon vacuum breaker must be elevated above the sill cock to operate properly. This would require elevated piping up to the vacuum breaker and down to the sill cock and is normally not a feasible installation. On the other hand, a hose bibb vacuum breaker can be attached directly to the sill cock, without plumbing changes and at minor cost.

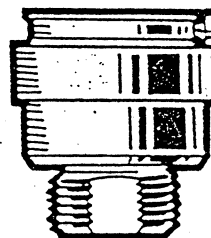

HOSE BIBB VACUUM BREAKER
FOR FROST-PROOF HYDRANTS
No. NF8

11 What is an atmospheric type vacuum breaker?

The most commonly used atmospheric type anti-siphon vacuum breakers incorporate an atmospheric vent in combination with a check valve. Its operation depends on a supply of potable water to seal off the atmospheric vent, admitting the water to downstream equipment. If a negative pressure develops in the supply line, the loss of pressure permits the check valve to drop sealing the orifice while at the same time the vent opens admitting air to the system to break the vacuum.

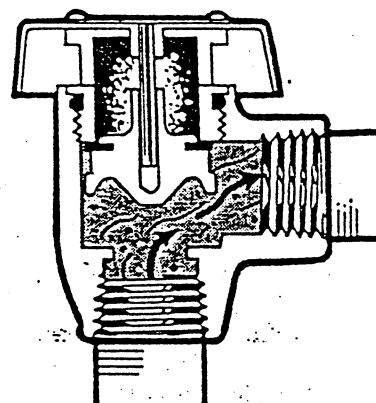

ATMOSPHERIC VACUUM BREAKER
No. 288A

12 Will an anti-siphon vacuum breaker protect against a backpressure backflow condition?

Absolutely not! If there is an increase in the downstream pressure over that of the supply pressure, the check valve would tend to "modulate" thus permitting the backflow of contaminated water to pass through the orifice into the potable water supply line.

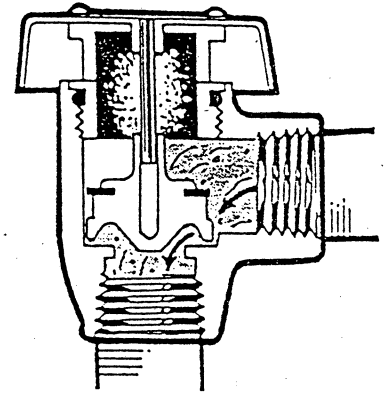

13 Can an atmospheric type vacuum breaker be used on lawn-sprinkler systems?

Yes, if these are properly installed, they will protect the potable water supply. The device shall be installed 6" above the highest sprinkler head and shall have no control valves located downstream from the device.

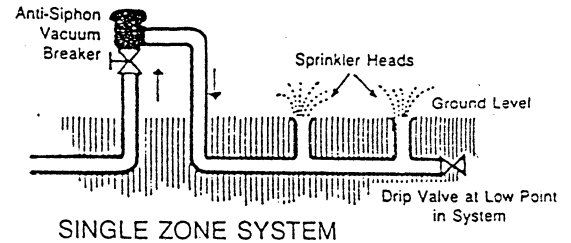

14 Can an atmospheric type vacuum breaker be used under continuous pressure?

No! Codes do not permit this as the device could become "frozen", and not function under an emergency condition.

15 Can a pressure vacuum breaker be used on a multi-zone lawn sprinkler system?

Yes. This type of vacuum breaker can be used under continuous pressure. Therefore, if properly installed, it will protect the potable water supply. The device shall be installed 12" above the highest sprinkler head.

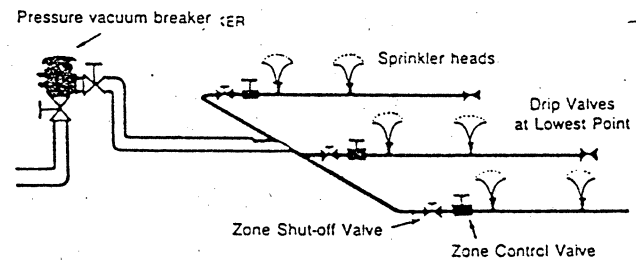

16 What is continuous pressure?

This is a term applied to an installation in which the pressure is being supplied continuously to a backflow preventive device for periods over 12 hours at a time. Laboratory faucet equipment, for example, is entirely suitable for a non-pressure, atmospheric type anti-siphon vacuum breaker because the supply is periodically being turned on and shut off. A vacuum breaker should never be subjected to continuous pressure unless it is of the continuous pressure type and clearly identified for this service.

17 Are check valves approved for use on boiler feed lines?

Most jurisdictions require backflow protection on all boiler feed lines. Some will allow a backflow preventer with intermediate vent as minimum protection for residential boilers. A reduced pressure backflow preventer is generally required on commercial and compound boilers.

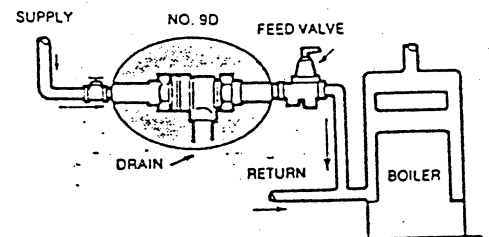

However, low cost, continuous pressure backflow preventers are now available which will perform with maximum protection; thus check valves are not recommended.

18 What is the difference between pollution and contamination?

Pollution of the water supply does not constitute an actual health hazard, although the quality of the water is impaired with respect to taste, odor or utility. Contamination of the water supply, however, does constitute an actual health hazard; the consumer being subjected to potentially lethal water borne disease or illness.

19 What recent case would reflect users being exposed to "pollution" of the water supply?

Pollution can sometimes be amusing. In December of 1970 in a winery in Cincinnati, Ohio the water supply valve was inadvertently left open after flushing out wine-distilling tanks. The result was that during a subsequent fermenting process, sparkling Burgundy backflowed from the vats into the city main and out of the kitchen faucets of nearby homeowners. This typical reversal of flow in water supply piping caused by the distilling tanks operating at a pressure higher than the city water supply did impair the condition of the water but did not make it dangerous. Indeed, many thought it was the best water they ever tasted.

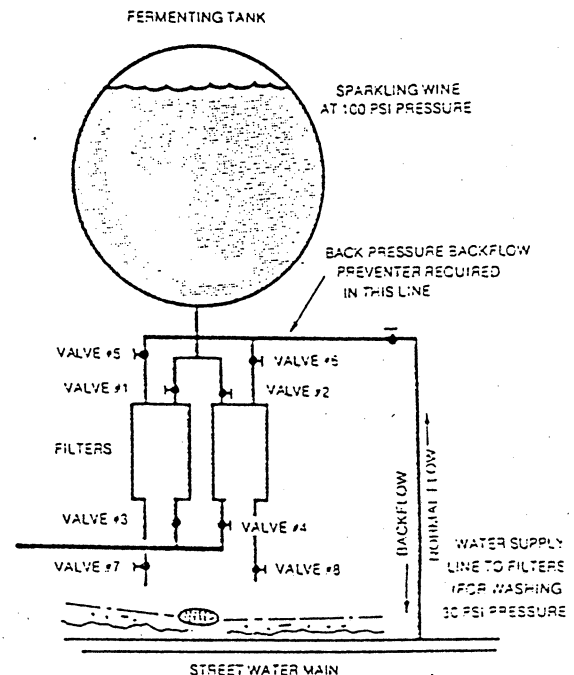

20 What recent case would reflect users being exposed to "contamination" of the water supply?

In May 1969 in a Pennsylvania college, the air conditioning system which contains dangerous chromates became blocked preventing circulation of the coolant. In an attempt to unblock the pipe line, a maintenance man inserted a hose in the pipe and attempted to dislodge the blockage by water pressure. A reversal of flow developed, allowing the chemicals in the air conditioning line to backflow through the hose and into the potable water supply. Unknowing students in other parts of the building subsequently drank what was thought to be potable water, resulting in illness to 23 persons.

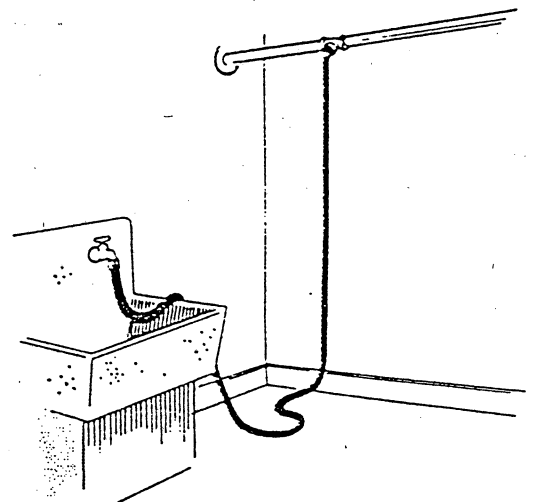

21 Are there any other records of recent cases involving unprotected cross connections?

The startling fact is that cross connections are increasing at the estimated rate of 100,000 per day and there are frequently documented cases involving reverse flow.

22 What recently reported cases occurred in a plant?

In addition to the case described in "No. 19", there are additional reports but because of the possibility of litigation for these pending cases, information is difficult to obtain. However,

in 1972 in San Francisco, an industrial plant had a submerged water inlet supplying a lye vat. Immediately adjacent to this installation was the employee's shower room. Officials fortunately discovered the cross connection, but were alarmed that employees could potentially be bathing in water contaminated with lye from the vats.

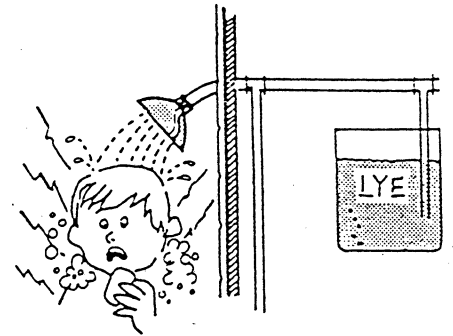

23 What recent case was reported involving a school?

Most people are familiar with the details of the Holy Cross Football Teams' "hepatitis" incident, which was later determined to be caused by a backflow of contaminated water. It took close to nine months for officials to determine that a severe fire in nearby Worcester lowered the pressure in the football field area to the point where a back pressure backflow condition was created allowing contaminants from a sunken hose bibb pit to backflow into the field house drinking bubbler.

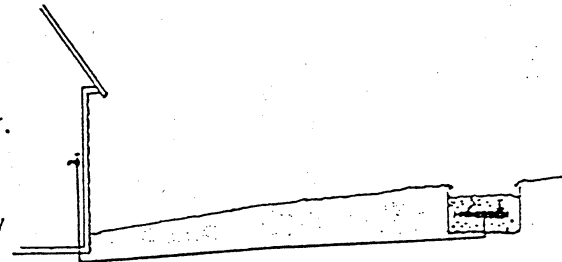

24 What recent case was reported involving a commercial bldg.?

Much to the surprise of the customers of a bank in Atlanta, Georgia they saw yellow water flowing from drinking fountains and green ice rolling out of cafeteria dispensing machines.

It was later reported that a pump, used for the air conditioning system, burned out; and a maintenance man, unaware of the danger, connected the system to another pump used for potable water. The result caused large doses of bichromate of soda to be forced into the potable water supply, causing the dramatic appearance of yellow water and colored ice cubes.



25 Are there any cases involving outside processing activities?

Yes, in 1972 a case occurred in a gravel pit operation in Illinois. A pump was used in the processing operation supplying 100 lbs. pressure. Contaminated water was forced back through an unprotected "prime line" overcoming the city water pressure of 45 lbs. The contaminated water entered the city main and was channeled into a nearby bottling plant. This probably would have gone undetected except that personnel in the bottling plant noticed that the water was not only dirty but was warm. City officials were immediately called which led to the discovery of the reverse flow from the gravel pit operation.

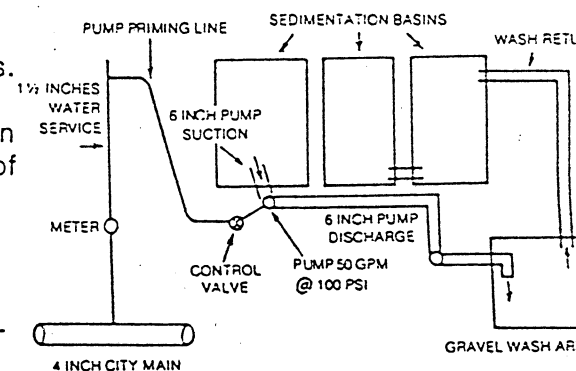

26 What other typical cases have been reported recently?

In 1972 an Automatic Car Wash injected gallons of a strong detergent solution into the city supply. The reverse flowing detergent was discovered in nearby homes more than a block away and was officially classified as being caused by an unprotected cross connection in the plumbing line.

In 1970 in Utah a Doctor reported two gold fish flowing into his bath tub. Earlier in the day he had been filling his gold fish pool with a garden hose when a back-siphonage condition developed resulting in the late emergence of the gold fish into the bath tub.

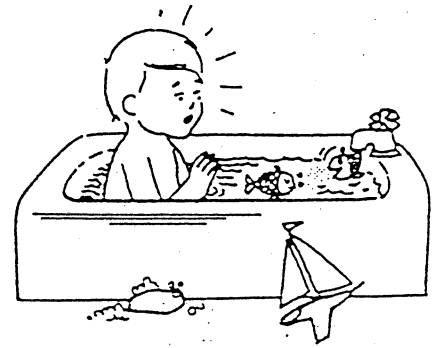

What is more significant, however, is the number of recent cases that have not been reported. With the number of unprotected cross connections in existence today, these are potential disasters which can occur any time unless adequate protective devices are installed.

27 What is meant by "Degree of Hazard"?

The degree of hazard is a commonly used phrase utilized in cross connection programs and is simply a determination on whether the substance in the non-potable system is toxic or non-toxic. Referencing No. 19 and No. 20, the winery would be a low hazard, while the air conditioning system would be a high hazard installation.

28 What is the difference between a toxic and a non-toxic substance?

Toxic substance is any liquid, solid or gas, which, when introduced into the water supply, creates, or may create, a danger to health and well-being of the consumer. An example is treated boiler water. A non-toxic substance is any substance that may create a moderate hazard, is a nuisance or is aesthetically objectionable. For example, food stuff, such as sugar, soda pop etc. Therefore, you must select the proper device according to the type of connection and degree of hazard. There are five basic devices that can be used to correct cross connection.



29 What are the five basic devices used for protection of cross connections?

The five basic devices are:

1. Air Gap
2. Atmospheric Vacuum Breakers - which also includes hose connection vacuum breakers.
3. Pressure Type Vacuum Breakers - which also includes Backflow Preventer with Intermediate Atmospheric Vent for 1/2" and 3/4" lines.
4. Double Check Valve Assembly
5. Reduced Pressure Principle Backflow Preventers.

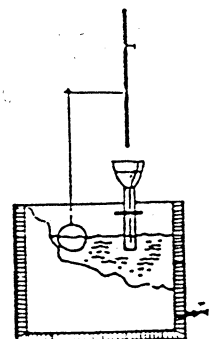
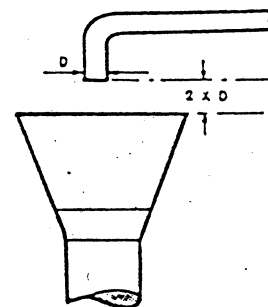

30 What is an Air Gap?

Air Gap is the physical separation of the potable and non-potable system by an air space. The vertical distance between

the supply pipe and the flood level rim should be two times the diameter of the supply pipe, but never less than 1". The air gap can be used on a direct or inlet connection and for all toxic substances.

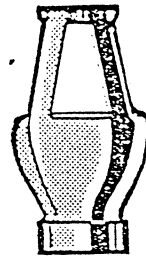

909AG Series

31 Where is an Atmospheric Type Vacuum Breaker used?

Atmospheric Vacuum Breakers may be used only on connections to a non-potable system where the vacuum breaker is never subjected to back-pressure and is installed on the discharge side of the last control valve. It must be installed above the usage point. It cannot be used under continuous pressure. (Also see No.11)

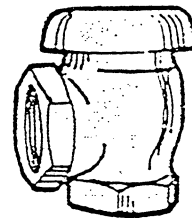

No. 233A

32 Where is a Hose Bibb Vacuum Breaker used?

Hose Bibb Vacuum Breakers are small inexpensive devices with hose connections which are simply attached to sill cocks, and threaded faucets or wherever there is a possibility of a hose being attached which could be introduced to a contaminant. However, like the Atmospheric Type Vacuum Breaker they should not be used under continuous pressure.

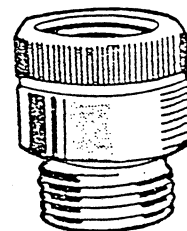

No. 8

33 Where is a Pressure Type Vacuum Breaker used?

Pressure Type Vacuum Breakers may be used as protection for connections to all types of non-potable systems where the vacuum breakers are not subject to back-pressure. These units may be used under continuous supply pressure. They must be installed above the usage point.

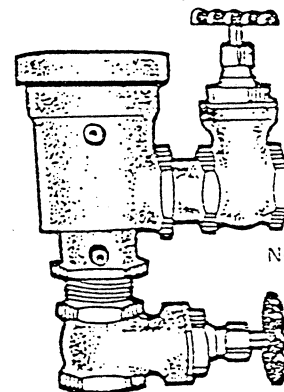

No. 800

34 Where is a Backflow Preventer with Intermediate Atmospheric Vent used?

These devices are made for 1/2" and 3/4" lines and may be used as an alternate equal for pressure type vacuum breakers. In addition, however, they provide the added advantage of providing protection against back-pressure.

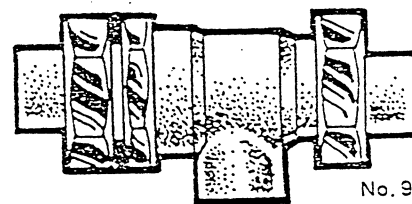

No. 9D

35 Where is a Double Check Valve Assembly used?

A double check valve assembly may be used as protection of all direct connections through which foreign material might enter the potable system in concentration which would constitute a nuisance or be aesthetically objectionable, such as air, steam, food, or other material which does not constitute a health hazard.

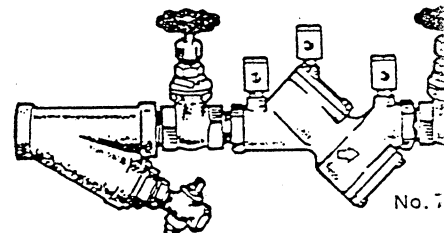

No. 7

36

Where is a Reduced Pressure Principle Backflow Preventer used?

Reduced Pressure Zone Devices may be used on all direct connections which may be subject to back-pressure or back-siphonage, and where there is the possibility of contamination by the material that does constitute a potential health hazard.

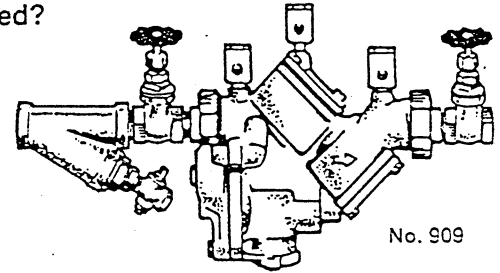

37

What are typical applications for an Air Gap?

Because today's complex plumbing systems normally require continuous pressure, air gap applications are actually in the minority. It should be remembered, however, that whenever a piping terminates a suitable distance above a contaminant, this itself is actually an air gap. Air Gaps are frequently used on industrial processing application, but care should be taken that subsequent alterations are not made to the piping which would result in a direct connection.

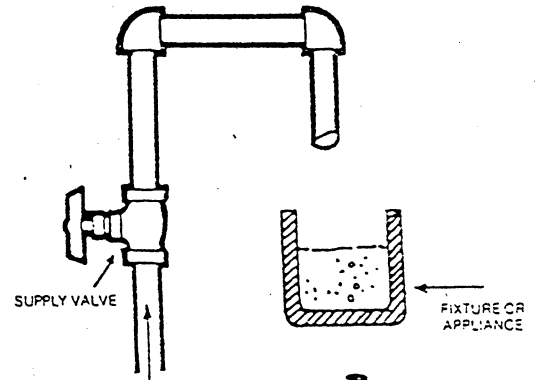

38

What are typical applications for Atmospheric Type Vacuum Breakers?

Atmospheric Type Vacuum Breakers can be used on most inlet type water connections which are not subject to back-pressure such as low inlet feeds to receptacles containing toxic and non-toxic substances, valve outlet or fixture with hose attachments, lawn-sprinkler systems and commercial dishwashers.

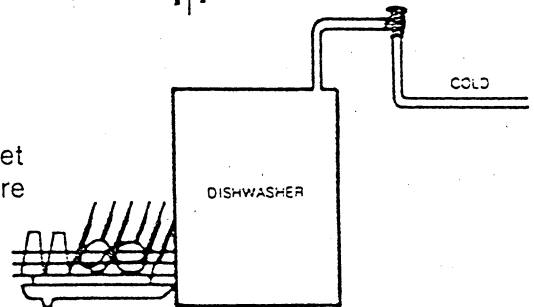

39

What are typical applications for Hose Bibb Vacuum Breakers?

Hose Bibb Vacuum Breakers are popularly used on sill cocks, service sinks and any threaded pipe to which a hose may potentially be attached.

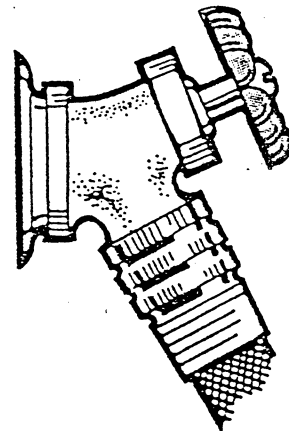

40

What are typical applications for Pressure Type Vacuum Breakers?

These applications should be similar to the Atmospheric Type Vacuum Breaker with the exception that these may be used under continuous pressure. However, they should not be subject to back-pressure.

41

What are typical applications of Backflow Preventer with Intermediate Vent?

For 1/2" and 3/4" lines these devices are popularly used on boiler feed water supply lines, cattle drinking fountains, trailer park water supply connections and other similar low-flow applications. They will protect against both back-siphonage and back-pressure and can be used under continuous pressure.

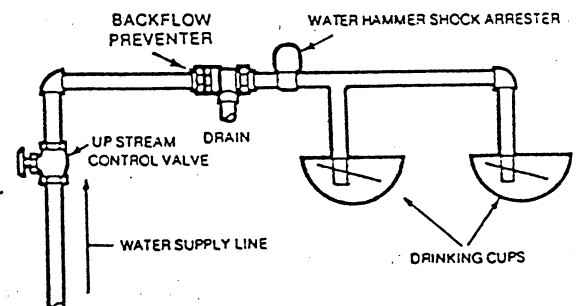

42 What are typical applications for Double Check Valve Assemblies?

Briefly, Double Check Valve Assemblies may be used where the degree of hazard is low, meaning that the non-potable source is polluted rather than contaminated. The degree of hazard is oftentimes determined by local Inspection Departments and, therefore, such departments should be questioned in order to comply with local regulations.

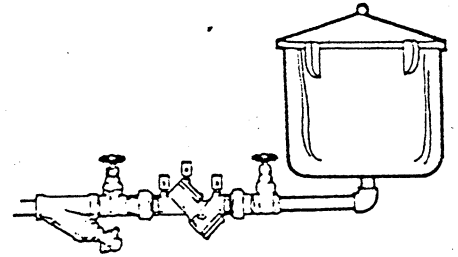

43 What are typical applications for Reduced Pressure Principle Backflow Preventers?

This type should be used whenever the non-potable source is more of a contaminant than a pollutant. Basically, they are applied as main line protection to protect the municipal water supply, but should also be used on branch line applications where non-potable fluid would constitute a health hazard, such as boiler feed lines, commercial garbage disposal systems, industrial boilers, etc.

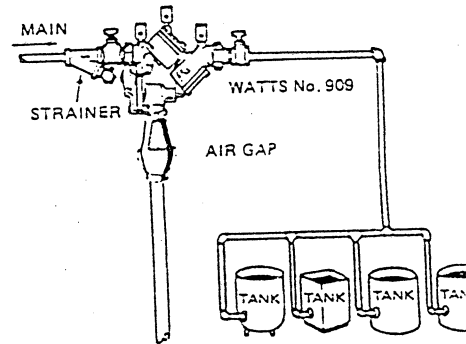

44 Are there any regulations in OSHA regarding cross connections?

Yes, OSHA requires that no cross connection be allowed in an installation unless it is properly protected with an approved backflow prevention device. These requirements are also covered in B.O.C.A., Southern Std. Building Code, Uniform Plumbing Code and City, State and Federal Regulations.

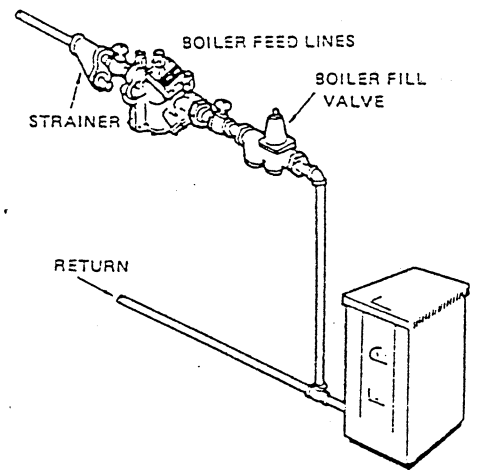

45 What Standards are available governing the manufacture of backflow prevention devices?

Table A on Page 12 provides a summary of the various standards available relating to specific types of backflow prevention devices.

46 What is the benefit of a strainer preceding a backflow preventer?

A strainer will protect the check valves of a backflow preventer from fouling due to foreign matter and debris which may be flowing through the line. This not only protects the device but eliminates nuisance fouling and subsequent maintenance and shutdown. The use of a strainer with a water pressure reducing valve has been an accepted practice for years. The amount of pressure drop attributed to the strainer is negligible and is far outweighed by the advantages provided by the strainer.

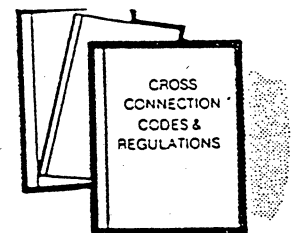

47 What would cause a reduced pressure principle backflow preventer to leak?

Leakage from a backflow preventer is normally attributed to foreign matter lodging on the seating area of either the first or second check valve. Most times this can be corrected by simply flushing the device which will dislodge any loose particles. It is, therefore, most important on new installations that the piping be thoroughly flushed before installing the unit. It should be remembered, however, that spillage does provide a "warning signal" that the device is in need of maintenance.

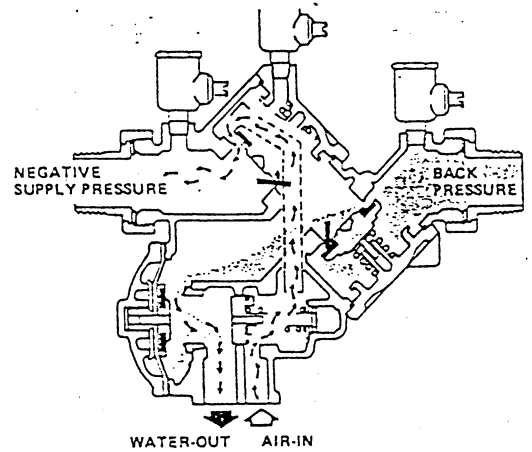

48 Is periodic testing required for reduced pressure principle backflow preventers?

Yes, and this is to ensure that the device is working properly and is a requirement of many states and cross connection control programs. Test cocks are provided on the device for this purpose and manufacturers are required to furnish field testing information.

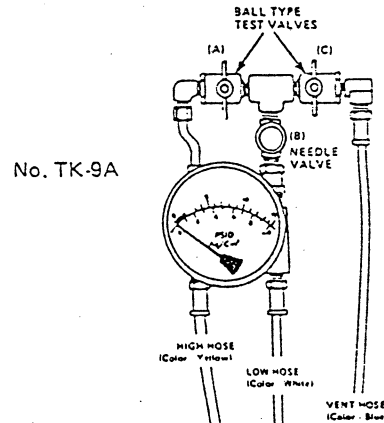

49 Should a backflow preventer be installed in the water supply line to each residence?

Because of the growing number of serious residential backflow cases, many water purveyors are now requiring the installation of approved dual check valve backflow preventers at residential water meters. They are also educating the public concerning cross connections and the danger of backflow into the local water supply. Since water purveyors cannot possibly be responsible for or monitor the use of water within a residence, the requirements for these cross connection control programs are increasing throughout the country.

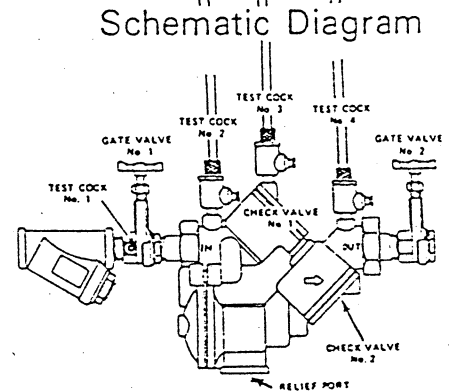

50 What is a cross connection control program?

This is a combined cooperative effort between plumbing and health officials, water works companies, property owners and certified testers to establish and administer guidelines for controlling cross connections and implementing means to ensure their enforcement so that the public potable water supply will be protected both in the city main and within buildings. The elements of a program define the type of protection required and responsibility for the administration and enforcement. Other elements ensure continuing education programs.



City of Cambridge

The Environment Committee conducted a public hearing on Tuesday, December 20, 1994 beginning at 2:37 p.m. in the Sullivan Chamber, City Hall.

Councillor Francis H. Duehay, Chair of the above referenced committee, convened the hearing and stated that the purpose of this dates proceedings was to discuss the Water Department's Cross Connection Control Program Pursuant to Massachusetts DEP Regulation 310 CMR 22.22 and to discuss a sidewalk usage issue concerning newspaper distribution boxes.

Present at the hearing were: Vice Mayor Sheila T. Russell, Councillor Kathleen L. Born, Councillor Michael A. Sullivan, Deputy City manager Richard C. Rossi, Managing Director Cambridge Water Department Michael Nicoloro, Public Works Commissioner Ralph Dunphy, Deputy City Solicitor Donald Drisdell, Representatives of the Fire, Inspectional and Health Departments and Deputy City Clerk John E. Flynn.

To begin the discussion Councillor Duehay recognized Mr. Nicoloro for the overview of the City of Cambridge Cross-Connection Program.

Mr. Nicoloro stated that this program is an important public safety component that is intended to protect the water supply. He noted that this program is monitored by the Commonwealth of Massachusetts Department of Environmental Protection (DEP) and regulated through 310 CMR 22.22 of the Drinking Water Regulations of Massachusetts. He also stated that a yearly briefing is required to educate and update elected and public officials and the public. As background Mr. Nicoloro stated that when the program began in December of 1989, 129 devices were in place at present 1657 and projected to increase to 4000 devices when the inventory is completed.

At present the program calls for a four step approach to the undertaken by the Water Department Personnel:

- 1) Survey of institution
- 2) Recommendation of appropriate device(s)
- 3) Testing of installed devices
- 4) Documentation.

The survey of institutions/facilities is required to be completed by December 31, 1996 and at present it is estimated that the department has completed 35%. (It should be noted that Cambridge is a delegation DEP cross connection program).

Mr. Sam Porter, Manager of Engineering -Cambridge Water Department, provided the Committee with an historical overview of the department's efforts in this area. He stated that under the DEP Cross Connection Program designation the water department had to establish a plan, receive approval of said plan by DEP, and then promulgate regulations. The time line was as follows:

- 1991 Water Board approved regulations - including \$85.00 fee.
- March 1992 - Test or re-test fee assessed.
- August 92 - Approval by (DEP).

The department is required to report on the program each May to the DEP with regards to information on Survey and testing and retesting. Steps to further expand the program include a marketing survey to new and existing concerns.

Mr. Anthony Ippolito, Cross Connection Manager Cambridge Water Department, outlined to the committee the procedure required to obtain a plumbing permit for the installation of a backflow prevention device. (A copy is attached). He also stated that the program is both an educational and ongoing process. He stated that of the 1657 devices Harvard and M.I.T. account for 750 devices. Other statistics provided include the following:

- 15 Funeral Homes - all backflow installed
- 6 Dentists - online
- Youville and Mt. Auburn Hospital - 99%
- Cambridge Hospital - improvement needed.

Mr. Ippolito then proceeded to review a publication entitled "50 Cross Connection Questions, Answers and Illustrations relating to Blackflow Prevention Products and Protection of Safe Drinking Water Supply" (A copy is attached). He also stated that this program does not include residential properties.

Commissioner Dunphy stated that the Public Works Department employs the new system, with active and passive recreational sites on line and the School Department facilities are at 100% compliance.

Councillor Born inquired if the issue was unique to Cambridge.

Mr. Ippolito responded in the negative citing that this was a mandated state program.

Councillor Duehay inquired if there was a compliance date for residential properties regarding the installation of appropriate devices. Mr. Ippolito responded in the negative but stated that DEP will provide a fact sheet in lay person terms identifying what protection is available.

Councillor Born inquired if there exists a contaminant issue.

Mr. Ippolito in response stated that in the Biotech institutions potable water is required on site.

Councillor Born inquired of the checks and balances that are in place.

Mr. Nicoloro stated that it is done through the permitting process.

Councillor Duehay inquired of where the City stands vis a vis compliance with other communities.

Mr. Ippolito stated that the City is close to the compliance levels of Springfield and Worcester. Mr. Nicoloro added that personnel has been added and the program is being carefully reviewed.

Councillor Duehay inquired of how organized the Survey is to ensure compliance.

In response Mr. Ippolito stated that the process in place is organized and efficient. Mr. Nicoloro added that in all goes back to the permit issuance process.

Commissioner Dunphy offered to share the Public Works Department's commercial recycling database to assist the Water Department in its efforts.

An official of the DEP stated for the record that the Commonwealth is very proud of the Cambridge Cross Connection Program.

Upon conclusion of this portion of the hearing Councillor Duehay steered the discussion towards the next issue at hand - newspaper boxes.

Councillor Duehay noted that it appears that the number of distribution boxes have multiplied and that a re-visit of the issue is warranted.

Mr. Rossi stated that boxes that have been affixed to trees, lamp posts, etc. have been removed by city personnel.

Mr. Drisdell cautioned that any action taken by the City Council will face potential litigation. He stated that the Law Department has been following other cases and it appears that the City can regulate based on public safety (free flow of pedestrians on sidewalks) and esthetics. He noted that a study would need to be undertaken to determine imitation and safety perimeters and that an ordinance if ordained would need to be content neutral and focus on safety.

Councillor Duehay inquired if a committee could be formed to study this issue and offer recommendations for consideration by the City Council.

Mr. Rossi responded in the affirmative with goals to include:

- reduce overall number of distribution boxes
- improve aesthetic appearance of boxes
- improve safe passage on sidewalks.
- imposition of reasonable fee.

The hearing adjourned at 4:28 p.m.

For the Committee,

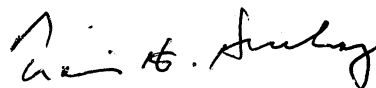

Councillor Francis H. Duehay,
Chair

1.

COMMITTEE REPORTS

S-70

Environment Committee Report for hearing held on December 20, 1994 relative to the Water Department's Cross Connection Control Program pursuant to Massachusetts DEPT Regulation 310 CMR 22.22 and a sidewalk usage issue regarding newspaper distribution boxes.

In City Council,

February 27, 1995

*Report accepted
Placed on file*